

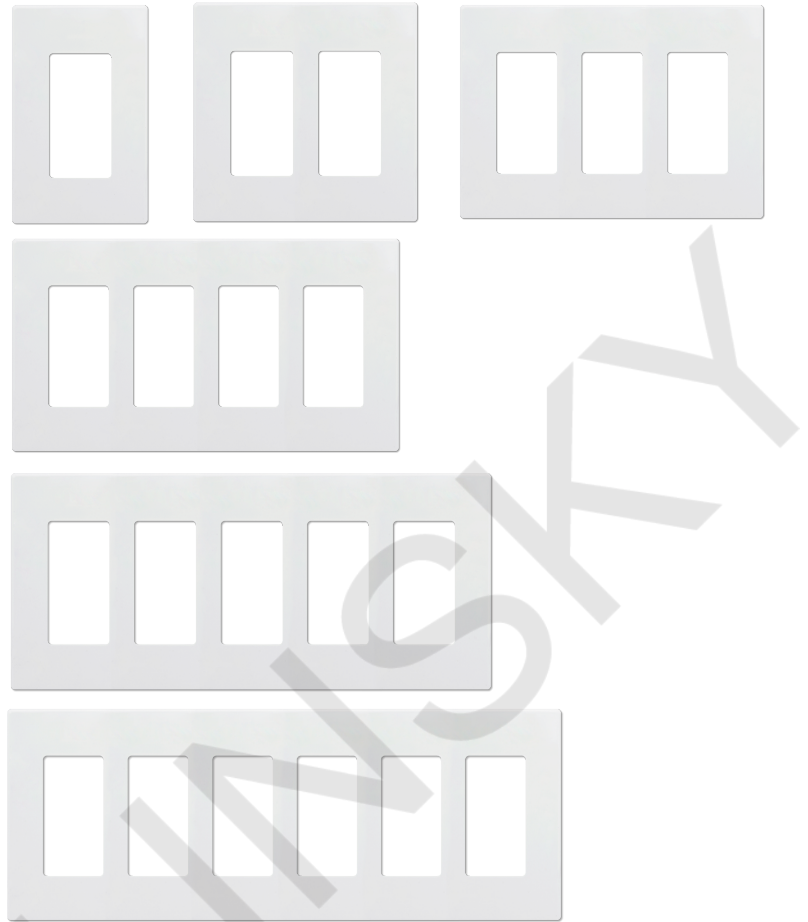

Wall Plate

— Various Colors Can Be Customised

- ◆ Perfect radian of the line, even more elegant appearance.
- ◆ Various colors can be customised – White, Ivory, Brown, Gray, Black, Red, Orange, Almond, and Light Almond.....
- ◆ 1-6 gang screwless wallplates each paired with a dedicted subplate for fast and easy installation.



Ordering Information:

Description	Color suffix	Catalog no.	QTY/CTN
Decorator Screwless Wall Plate			
1-gang 	A, B, BK, GY, LA, RD, RN, V, W	WSL-01	200pcs
2-gang 	A, B, BK, GY, LA, RD, RN, V, W	WSL-02	200pcs
3-gang 	A, B, BK, GY, LA, RD, RN, V, W	WSL-03	200pcs
4-gang 	A, B, BK, GY, LA, RD, RN, V, W	WSL-04	200pcs
5-gang 	A, B, BK, GY, LA, RD, RN, V, W	WSL-05	200pcs
6-gang 	A, B, BK, GY, LA, RD, RN, V, W	WSL-06	200pcs

Color ordering information:

For ordering devices, include Catalog no. followed by the Color suffix: A (Almond), B (Brown), BK (Black), GY (Gray), LA (Light Almond), RD (Red), RN (Orange), V (Ivory), W (White)



Dimensional Drawings:

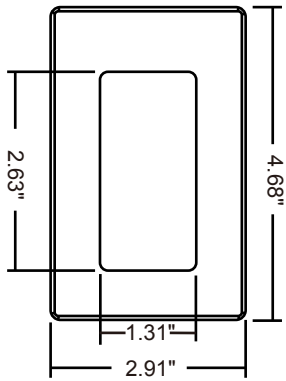

WSL-01

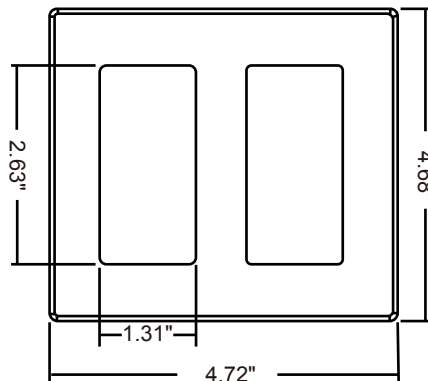

WSL-02

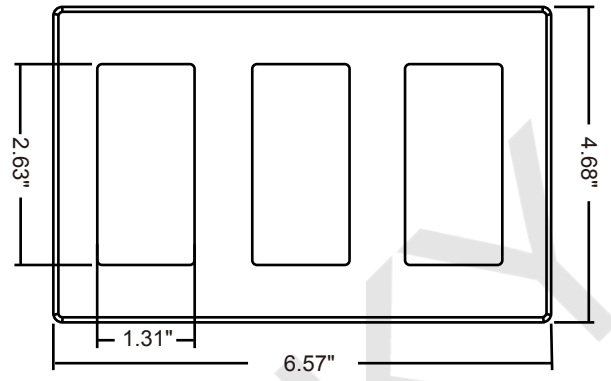

WSL-03

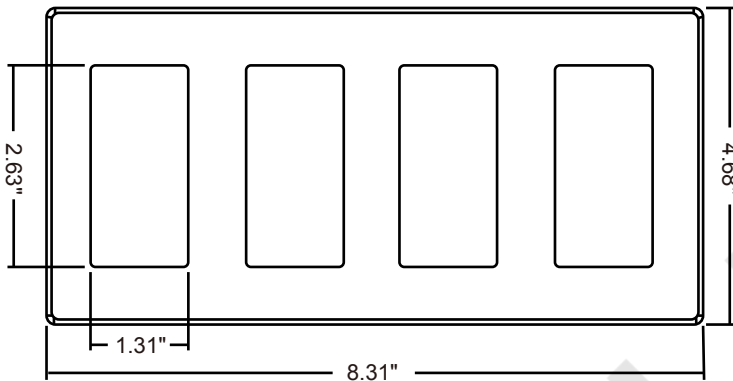

WSL-04

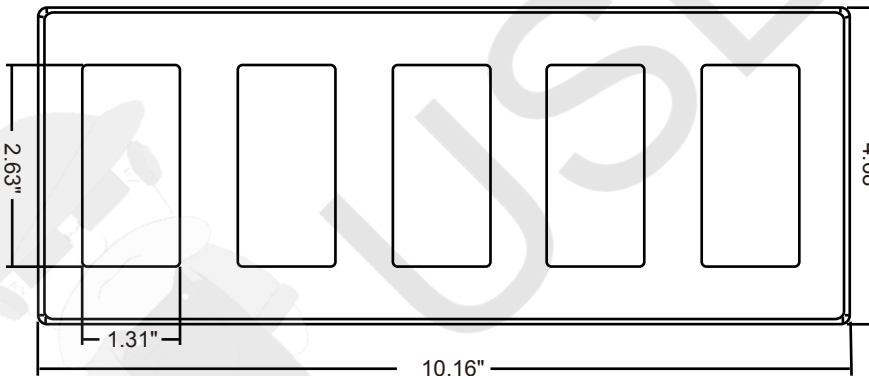

WSL-05

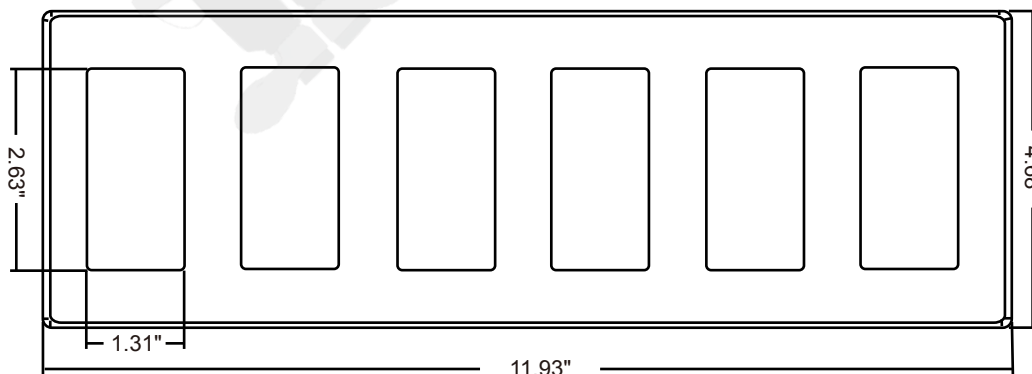

WSL-06



Thermoset Plastic Wall Plate







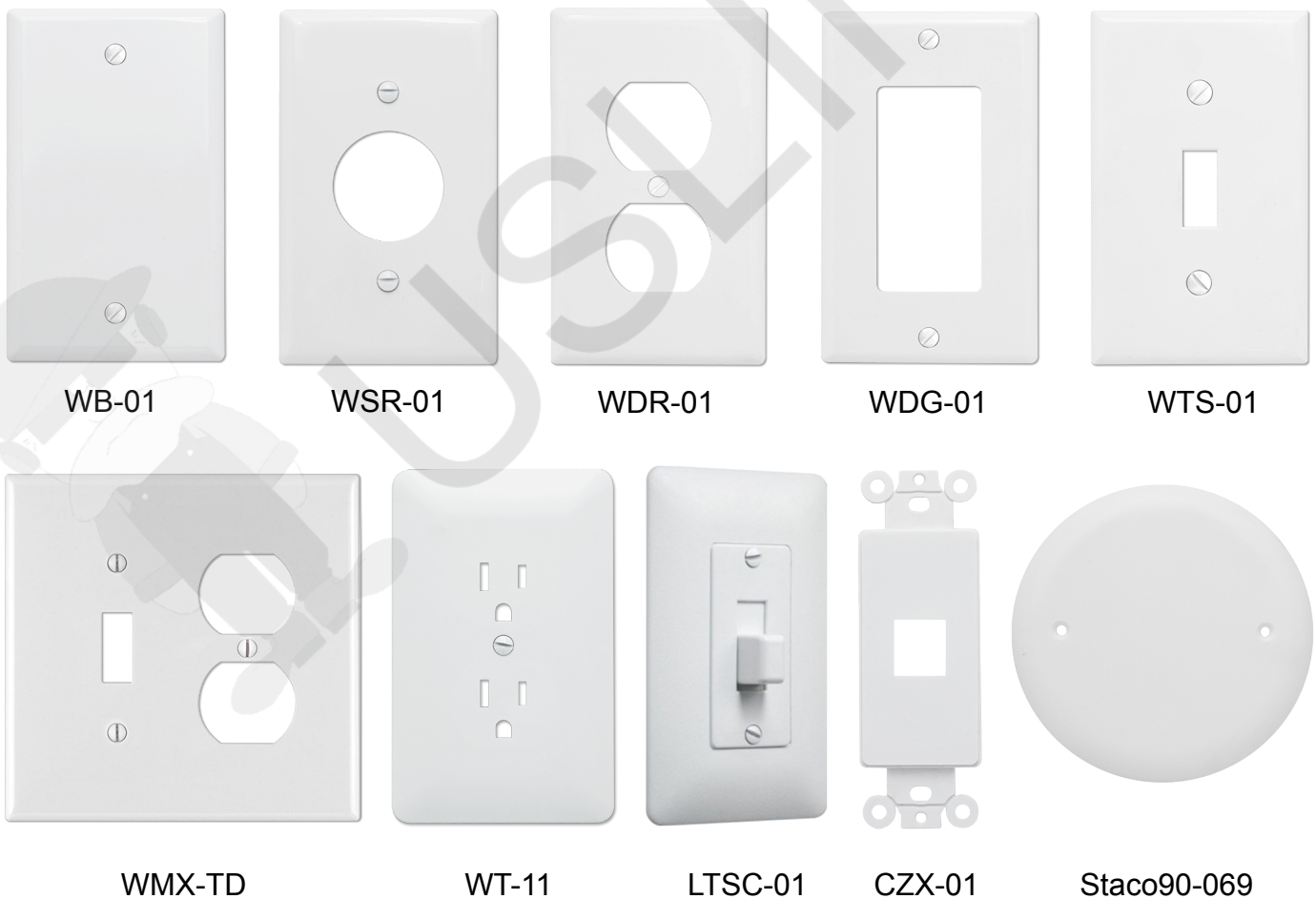

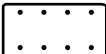
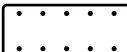
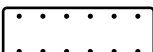

- ◆ Molded of non-combustible mar-proof material.
- ◆ Available in plastic wall plate series in Standard, Mid-size and Over-size.
- ◆ Various colors can be customised – White, Ivory, Brown, Gray, Black, Red, Orange, Almond, and Light Almond.....
- ◆ Individually wrapped with color-matching screws.
- ◆ Resistant to discoloration, grease, oil, solvent and moisture.
- ◆ Nominal thickness, 0.070"

Standard Plastic Wall Plate



Ordering Information:













Description	Color suffix	Catalog no.	QTY/CTN
Blank Plastic Wall Plate			
1-gang 	A, B, BK, GY, LA, RD, RN, V, W	WB-01	200pcs
2-gang 	A, B, BK, GY, LA, RD, RN, V, W	WB-02	200pcs
3-gang 	A, B, BK, GY, LA, RD, RN, V, W	WB-03	200pcs
4-gang 	A, B, BK, GY, LA, RD, RN, V, W	WB-04	200pcs
5-gang 	A, B, BK, GY, LA, RD, RN, V, W	WB-05	200pcs
6-gang 	A, B, BK, GY, LA, RD, RN, V, W	WB-06	200pcs
Receptacle Plastic Wall Plate			
1-gang 	A, B, BK, GY, LA, RD, RN, V, W	WSR-01	200pcs
2-gang 	A, B, BK, GY, LA, RD, RN, V, W	WSR-02	200pcs
3-gang 	A, B, BK, GY, LA, RD, RN, V, W	WSR-03	200pcs
4-gang 	A, B, BK, GY, LA, RD, RN, V, W	WSR-04	200pcs
5-gang 	A, B, BK, GY, LA, RD, RN, V, W	WSR-05	200pcs
6-gang 	A, B, BK, GY, LA, RD, RN, V, W	WSR-06	200pcs

Color ordering information:

For ordering devices, include Catalog no. followed by the Color suffix: A (Almond), B (Brown), BK (Black), GY (Gray), LA (Light Almond), RD (Red), RN (Orange), V (Ivory), W (White)

A	B	BK	GY	LA	RD	RN	V	W
(Almond)	(Brown)	(Black)	(Gray)	(Light Almond)	(Red)	(Orange)	(Ivory)	(White)



Description	Color suffix	Catalog no.	QTY/CTN
Duplex Plastic Wall Plate			
1-gang 	A, B, BK, GY, LA, RD, RN, V, W	WDR-01	200pcs
2-gang 	A, B, BK, GY, LA, RD, RN, V, W	WDR-02	200pcs
3-gang 	A, B, BK, GY, LA, RD, RN, V, W	WDR-03	200pcs
4-gang 	A, B, BK, GY, LA, RD, RN, V, W	WDR-04	200pcs
5-gang 	A, B, BK, GY, LA, RD, RN, V, W	WDR-05	200pcs
6-gang 	A, B, BK, GY, LA, RD, RN, V, W	WDR-06	200pcs
Decorator Plastic Wall Plate			
1-gang 	A, B, BK, GY, LA, RD, RN, V, W	WDG-01	200pcs
2-gang 	A, B, BK, GY, LA, RD, RN, V, W	WDG-02	200pcs
3-gang 	A, B, BK, GY, LA, RD, RN, V, W	WDG-03	200pcs
4-gang 	A, B, BK, GY, LA, RD, RN, V, W	WDG-04	200pcs
5-gang 	A, B, BK, GY, LA, RD, RN, V, W	WDG-05	200pcs
6-gang 	A, B, BK, GY, LA, RD, RN, V, W	WDG-06	200pcs

Color ordering information:

For ordering devices, include Catalog no. followed by the Color suffix: A (Almond), B (Brown), BK (Black), GY (Gray), LA (Light Almond), RD (Red), RN (Orange), V (Ivory), W (White)

A	B	BK	GY	LA	RD	RN	V	W
(Almond)	(Brown)	(Black)	(Gray)	(Light Almond)	(Red)	(Orange)	(Ivory)	(White)











Description	Color suffix	Catalog no.	QTY/CTN
Toggle Plastic Wall Plate			
1-gang 	A, B, BK, GY, LA, RD, RN, V, W	WTS-01	200pcs
2-gang 	A, B, BK, GY, LA, RD, RN, V, W	WTS-02	200pcs
3-gang 	A, B, BK, GY, LA, RD, RN, V, W	WTS-03	200pcs
4-gang 	A, B, BK, GY, LA, RD, RN, V, W	WTS-04	200pcs
5-gang 	A, B, BK, GY, LA, RD, RN, V, W	WTS-05	200pcs
6-gang 	A, B, BK, GY, LA, RD, RN, V, W	WTS-06	200pcs
Paintable Duplex Outlet Cover			
1-gang 	W	WT-11	200pcs
Toggle Switch Cover-up Wall Plate			
1-gang 	W	LTSC-01	200pcs
2-gang 	W	LTSC-02	200pcs
Wall Plate Insert			
1-gang 	W	CZX-00	200pcs
1-gang 	W	CZX-01	200pcs
2-gang 	W	CZX-02	200pcs

Color ordering information:

For ordering devices, include Catalog no. followed by the Color suffix: A (Almond), B (Brown), BK (Black), GY (Gray), LA (Light Almond), RD (Red), RN (Orange), V (Ivory), W (White)

 A	 B	 BK	 GY	 LA	 RD	 RN	 V	 W
(Almond)	(Brown)	(Black)	(Gray)	(Light Almond)	(Red)	(Orange)	(Ivory)	(White)



Description	Color suffix	Catalog no.	QTY/CTN
Toggle & Duplex Plastic Wall Plate			
2-gang 	A, B, BK, GY, LA, RD, RN, V, W	WMX-TD	200pcs
Toggle & Decorator Plastic Wall Plate			
2-gang 	A, B, BK, GY, LA, RD, RN, V, W	WMX-TG	200pcs
Duplex & Decorator Plastic Wall Plate			
2-gang 	A, B, BK, GY, LA, RD, RN, V, W	WMX-DG	200pcs
Blank & Toggle Plastic Wall Plate			
2-gang 	A, B, BK, GY, LA, RD, RN, V, W	WMX-BT	200pcs
Blank & Duplex Plastic Wall Plate			
2-gang 	A, B, BK, GY, LA, RD, RN, V, W	WMX-BD	200pcs
Blank & Decorator Plastic Wall Plate			
2-gang 	A, B, BK, GY, LA, RD, RN, V, W	WMX-BG	200pcs
Duplex & Receptacle Plastic Wall Plate			
2-gang 	A, B, BK, GY, LA, RD, RN, V, W	WMX-DS	200pcs
Decorator & Receptacle Plastic Wall Plate			
2-gang 	A, B, BK, GY, LA, RD, RN, V, W	WMX-GS	200pcs
5" Ceing Wall Plate			
Round 	W	Staco90-069	200pcs

Color ordering information:

For ordering devices, include Catalog no. followed by the Color suffix: A (Almond), B (Brown), BK (Black), GY (Gray), LA (Light Almond), RD (Red), RN (Orange), V (Ivory), W (White)

 A	 B	 BK	 GY	 LA	 RD	 RN	 V	 W
(Almond)	(Brown)	(Black)	(Gray)	(Light Almond)	(Red)	(Orange)	(Ivory)	(White)



Dimensional Drawings:

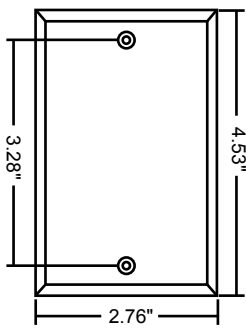
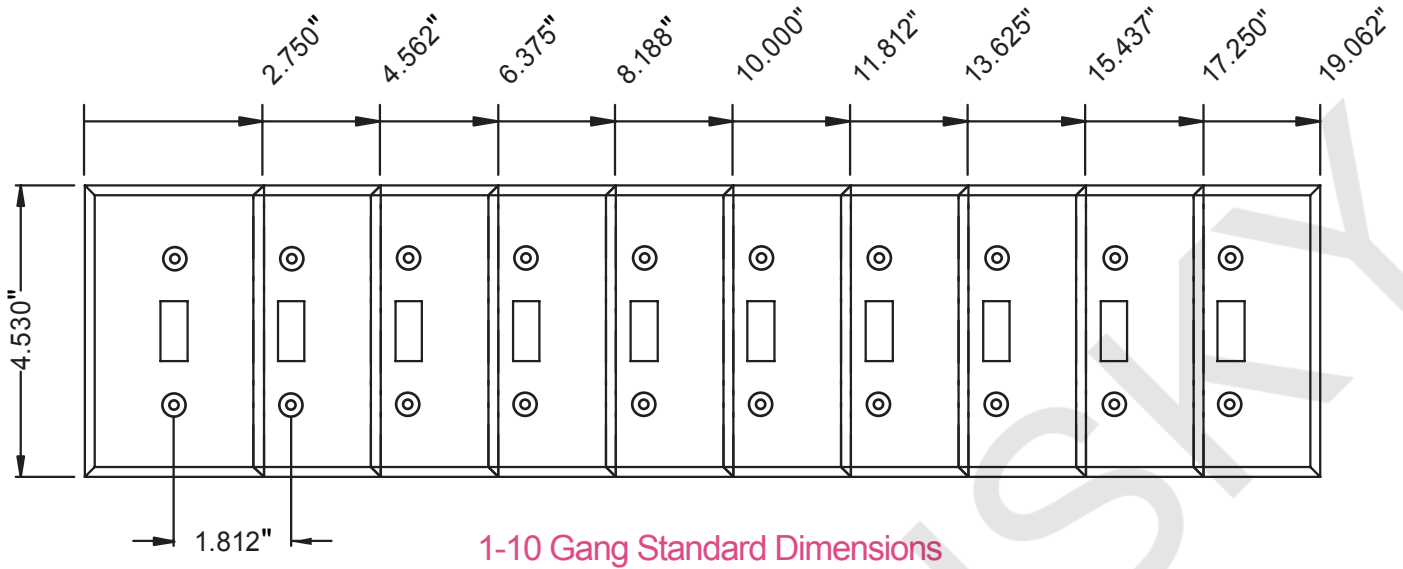

WB-01

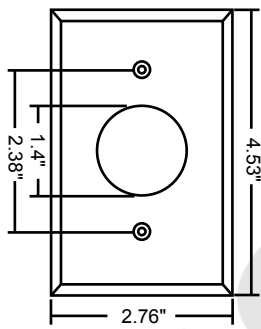

WSR-01

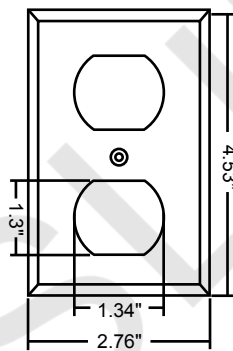

WDR-01

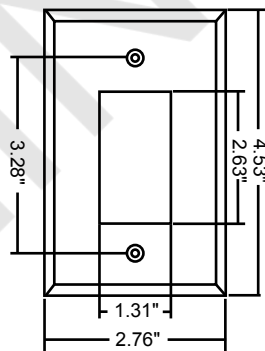

WDG-01

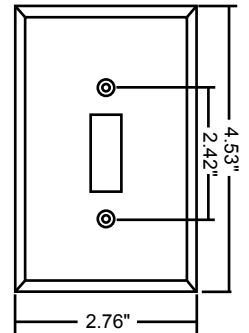

WTS-01

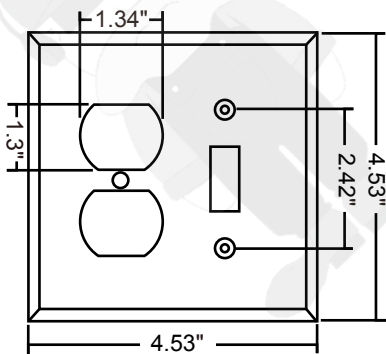

WMX-TD

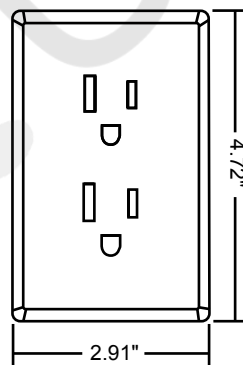

WT-11

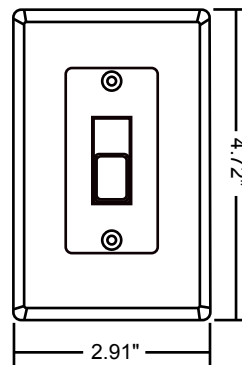

LTSC-01

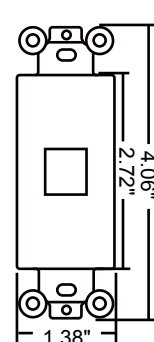

CZX-01

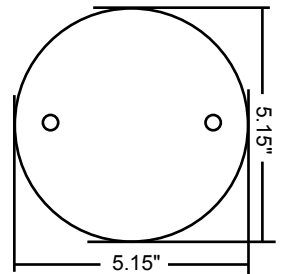

Staco90-069





Mid-size/Over-size Plastic Wall Plate



WDG-01M

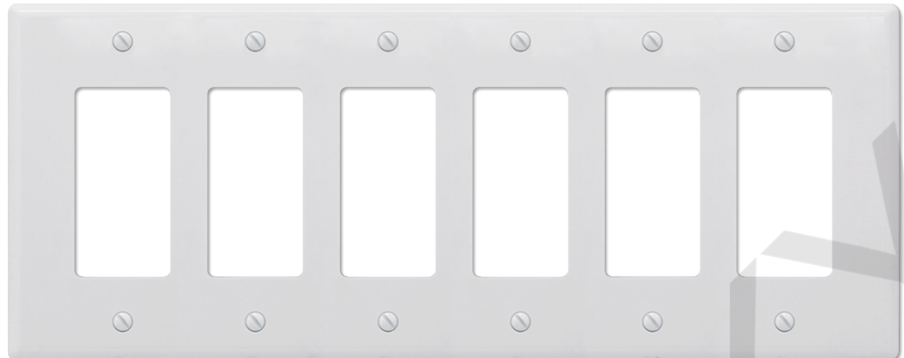

WDG-06M



WMB-01



WMT-01



WMD-01



WMS-01









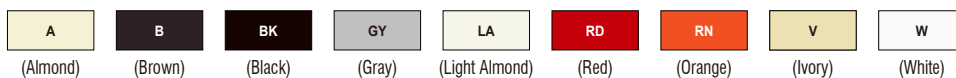

Ordering Information:

Description	Color suffix	Catalog no.	QTY/CTN
Mid-size Decorator Plastic Wall Plate			
1-gang 	A, B, BK, GY, LA, RD, RN, V, W	WDG-01M	200pcs
2-gang 	A, B, BK, GY, LA, RD, RN, V, W	WDG-02M	200pcs
3-gang 	A, B, BK, GY, LA, RD, RN, V, W	WDG-03M	200pcs
4-gang 	A, B, BK, GY, LA, RD, RN, V, W	WDG-04M	200pcs
5-gang 	A, B, BK, GY, LA, RD, RN, V, W	WDG-05M	200pcs
6-gang 	A, B, BK, GY, LA, RD, RN, V, W	WDG-06M	200pcs

Color ordering information:

For ordering devices, include Catalog no. followed by the Color suffix: A (Almond), B (Brown), BK (Black), GY (Gray), LA (Light Almond), RD (Red), RN (Orange), V (Ivory), W (White)



Description	Color suffix	Catalog no.	QTY/CTN
Mid-size Blank Plastic Wall Plate			
1-gang 	A, B, BK, GY, LA, RD, RN, V, W	WMB-01	200pcs
Mid-size Toggle Plastic Wall Plate			
1-gang 	A, B, BK, GY, LA, RD, RN, V, W	WMT-01	200pcs
Mid-size Duplex Plastic Wall Plate			
1-gang 	A, B, BK, GY, LA, RD, RN, V, W	WMD-01	200pcs
Mid-size Receptacle Plastic Wall Plate			
1-gang 	A, B, BK, GY, LA, RD, RN, V, W	WMS-01	200pcs
Over-size Decorator Plastic Wall Plate			
1-gang 	A, B, BK, GY, LA, RD, RN, V, W	WDG-01L	200pcs
2-gang 	A, B, BK, GY, LA, RD, RN, V, W	WDG-02L	200pcs
3-gang 	A, B, BK, GY, LA, RD, RN, V, W	WDG-03L	200pcs
4-gang 	A, B, BK, GY, LA, RD, RN, V, W	WDG-04L	200pcs
5-gang 	A, B, BK, GY, LA, RD, RN, V, W	WDG-05L	200pcs
6-gang 	A, B, BK, GY, LA, RD, RN, V, W	WDG-06L	200pcs

Color ordering information:

For ordering devices, include Catalog no. followed by the Color suffix: A (Almond), B (Brown), BK (Black), GY (Gray), LA (Light Almond), RD (Red), RN (Orange), V (Ivory), W (White)



Dimensional Drawings:

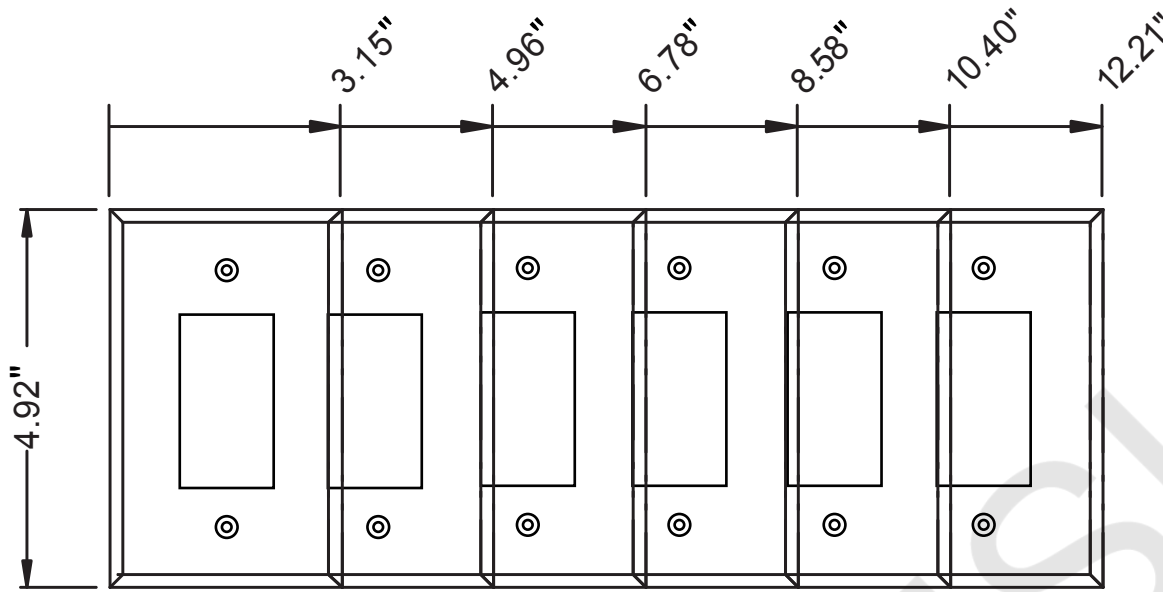

1-6 Gang Mid-size Dimensions

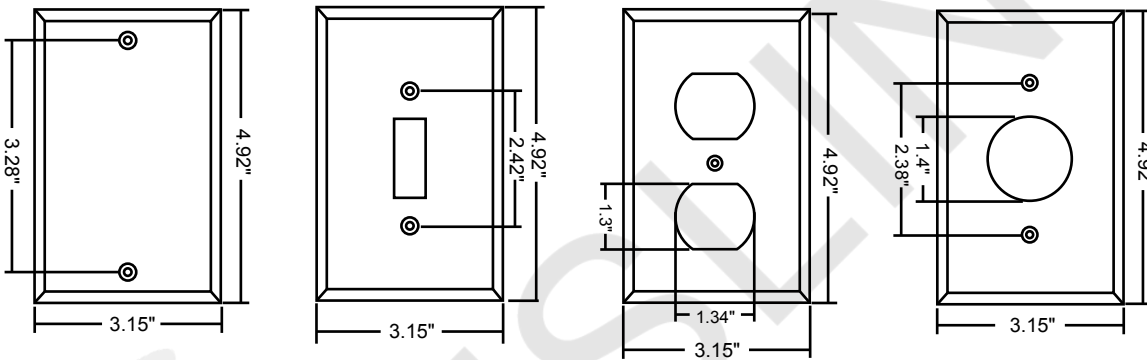

WMB-01

WMT-01

WMD-01

WMS-01

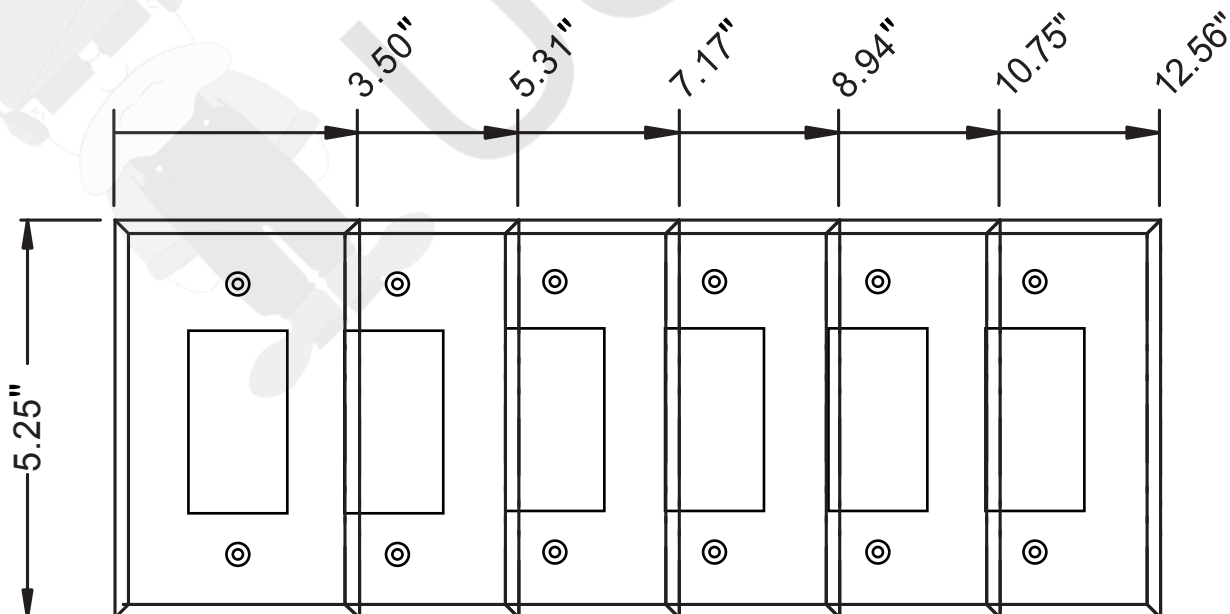

1-6 Gang Over-size Dimensions



Features and Benefits



- ◆ Smooth contours provide a modern, clean aesthetic
- ◆ Available in Type 201 Stainless Steel (magnetic) for general commercial use and good corrosion resistance in indoor applications
- ◆ Satin finish
- ◆ Various colors can be customised – White, Ivory, Brown, Gray, Black, Red, Orange, Almond, and Light Almond.....
- ◆ Midway sizes available in some configurations
- ◆ Includes matching mounting screws

Stainless Steel Wall Plate



WB-01SS



WSR-01SS

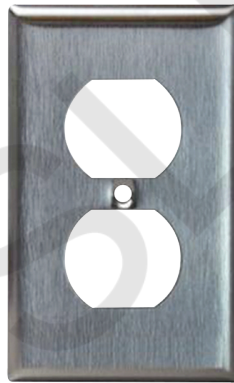

WDR-01SS



WDG-01SS



WTS-01SS



WTS-01SS(Red)

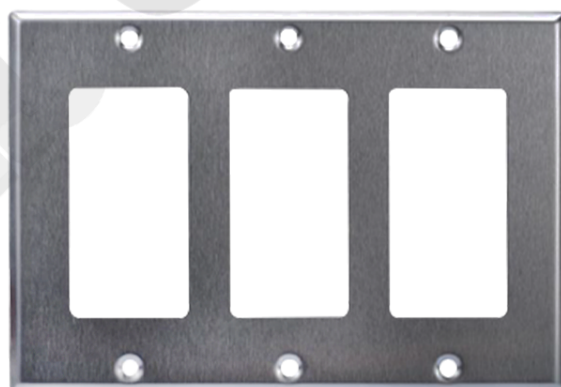



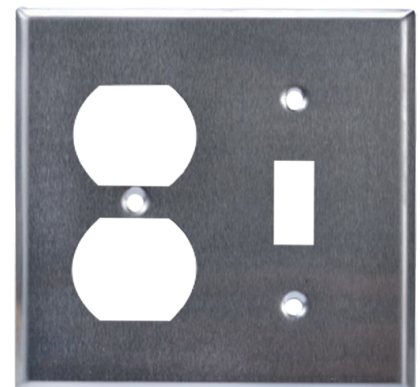





WDG-03SS

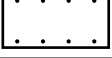
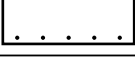
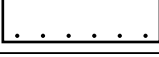

WMX-TDSS











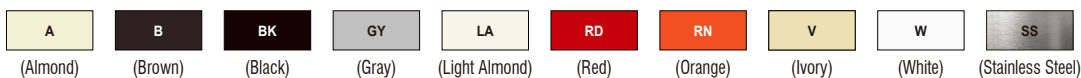

Ordering Information:

Description	Color suffix	Catalog no.	QTY/CTN
Blank Stainless Steel Wall Plate			
1-gang 	A, B, BK, GY, LA, RD, RN, V, W, SS	WB-01SS	300pcs
2-gang 	A, B, BK, GY, LA, RD, RN, V, W, SS	WB-02SS	200pcs
3-gang 	A, B, BK, GY, LA, RD, RN, V, W, SS	WB-03SS	100pcs
4-gang 	A, B, BK, GY, LA, RD, RN, V, W, SS	WB-04SS	100pcs
5-gang 	A, B, BK, GY, LA, RD, RN, V, W, SS	WB-05SS	100pcs
6-gang 	A, B, BK, GY, LA, RD, RN, V, W, SS	WB-06SS	100pcs
Receptacle Stainless Steel Wall Plate			
1-gang 	A, B, BK, GY, LA, RD, RN, V, W, SS	WSR-01SS	300pcs
2-gang 	A, B, BK, GY, LA, RD, RN, V, W, SS	WSR-02SS	200pcs
3-gang 	A, B, BK, GY, LA, RD, RN, V, W, SS	WSR-03SS	100pcs
4-gang 	A, B, BK, GY, LA, RD, RN, V, W, SS	WSR-04SS	100pcs
5-gang 	A, B, BK, GY, LA, RD, RN, V, W, SS	WSR-05SS	100pcs
6-gang 	A, B, BK, GY, LA, RD, RN, V, W, SS	WSR-06SS	100pcs

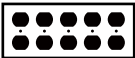
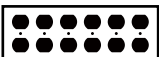
Color ordering information:

For ordering devices, include Catalog no. followed by the Color suffix: A (Almond), B (Brown), BK (Black), GY (Gray), LA (Light Almond), RD (Red), RN (Orange), V (Ivory), W (White), SS (Stainless Steel)









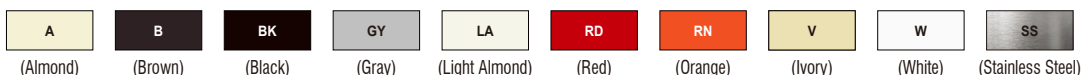



Description	Color suffix	Catalog no.	QTY/CTN
Duplex Stainless Steel Wall Plate			
1-gang 	A, B, BK, GY, LA, RD, RN, V, W, SS	WDR-01SS	300pcs
2-gang 	A, B, BK, GY, LA, RD, RN, V, W, SS	WDR-02SS	200pcs
3-gang 	A, B, BK, GY, LA, RD, RN, V, W, SS	WDR-03SS	100pcs
4-gang 	A, B, BK, GY, LA, RD, RN, V, W, SS	WDR-04SS	100pcs
5-gang 	A, B, BK, GY, LA, RD, RN, V, W, SS	WDR-05SS	100pcs
6-gang 	A, B, BK, GY, LA, RD, RN, V, W, SS	WDR-06SS	100pcs
Decorator Stainless Steel Wall Plate			
1-gang 	A, B, BK, GY, LA, RD, RN, V, W, SS	WDG-01SS	300pcs
2-gang 	A, B, BK, GY, LA, RD, RN, V, W, SS	WDG-02SS	200pcs
3-gang 	A, B, BK, GY, LA, RD, RN, V, W, SS	WDG-03SS	100pcs
4-gang 	A, B, BK, GY, LA, RD, RN, V, W, SS	WDG-04SS	100pcs
5-gang 	A, B, BK, GY, LA, RD, RN, V, W, SS	WDG-05SS	100pcs
6-gang 	A, B, BK, GY, LA, RD, RN, V, W, SS	WDG-06SS	100pcs

Color ordering information:

For ordering devices, include Catalog no. followed by the Color suffix: A (Almond), B (Brown), BK (Black), GY (Gray), LA (Light Almond), RD (Red), RN (Orange), V (Ivory), W (White), SS (Stainless Steel)





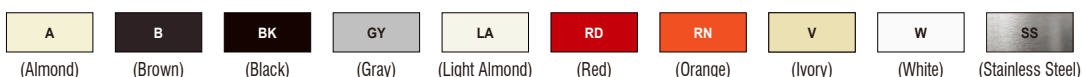

Description	Color suffix	Catalog no.	QTY/CTN
Toggle Stainless Steel Wall Plate			
1-gang 	A, B, BK, GY, LA, RD, RN, V, W, SS	WTS-01SS	300pcs
2-gang 	A, B, BK, GY, LA, RD, RN, V, W, SS	WTS-02SS	200pcs
3-gang 	A, B, BK, GY, LA, RD, RN, V, W, SS	WTS-03SS	100pcs
4-gang 	A, B, BK, GY, LA, RD, RN, V, W, SS	WTS-04SS	100pcs
5-gang 	A, B, BK, GY, LA, RD, RN, V, W, SS	WTS-05SS	100pcs
6-gang 	A, B, BK, GY, LA, RD, RN, V, W, SS	WTS-06SS	100pcs
Toggle & Duplex Stainless Steel Wall Plate			
2-gang 	A, B, BK, GY, LA, RD, RN, V, W, SS	WMX-TDSS	200pcs
Toggle & Decorator Stainless Steel Wall Plate			
2-gang 	A, B, BK, GY, LA, RD, RN, V, W, SS	WMX-TGSS	200pcs
Duplex & Decorator Stainless Steel Wall Plate			
2-gang 	A, B, BK, GY, LA, RD, RN, V, W, SS	WMX-DGSS	200pcs
Blank & Toggle Stainless Steel Wall Plate			
2-gang 	A, B, BK, GY, LA, RD, RN, V, W, SS	WMX-BTSS	200pcs

Color ordering information:

For ordering devices, include Catalog no. followed by the Color suffix: A (Almond), B (Brown), BK (Black), GY (Gray), LA (Light Almond), RD (Red), RN (Orange), V (Ivory), W (White), SS (Stainless Steel)



Description	Color suffix	Catalog no.	QTY/CTN
Blank & Duplex Stainless Steel Wall Plate			
2-gang 	A, B, BK, GY, LA, RD, RN, V, W, SS	WMX-BDSS	200pcs
Blank & Decorator Stainless Steel Wall Plate			
2-gang 	A, B, BK, GY, LA, RD, RN, V, W, SS	WMX-BGSS	200pcs
Duplex & Receptacle Stainless Steel Wall Plate			
2-gang 	A, B, BK, GY, LA, RD, RN, V, W, SS	WMX-DSSS	200pcs
Decorator & Receptacle Stainless Steel Wall Plate			
2-gang 	A, B, BK, GY, LA, RD, RN, V, W, SS	WMX-GSSS	200pcs

Color ordering information:

For ordering devices, include Catalog no. followed by the Color suffix: A (Almond), B (Brown), BK (Black), GY (Gray), LA (Light Almond), RD (Red), RN (Orange), V (Ivory), W (White), SS (Stainless Steel)

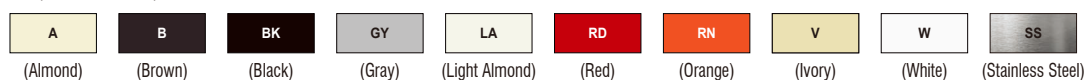

Dimensional Drawings:

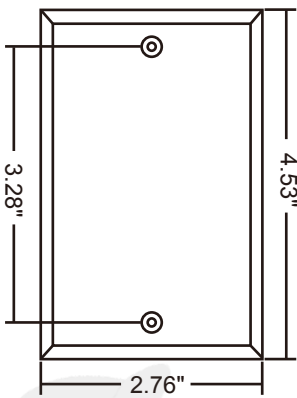
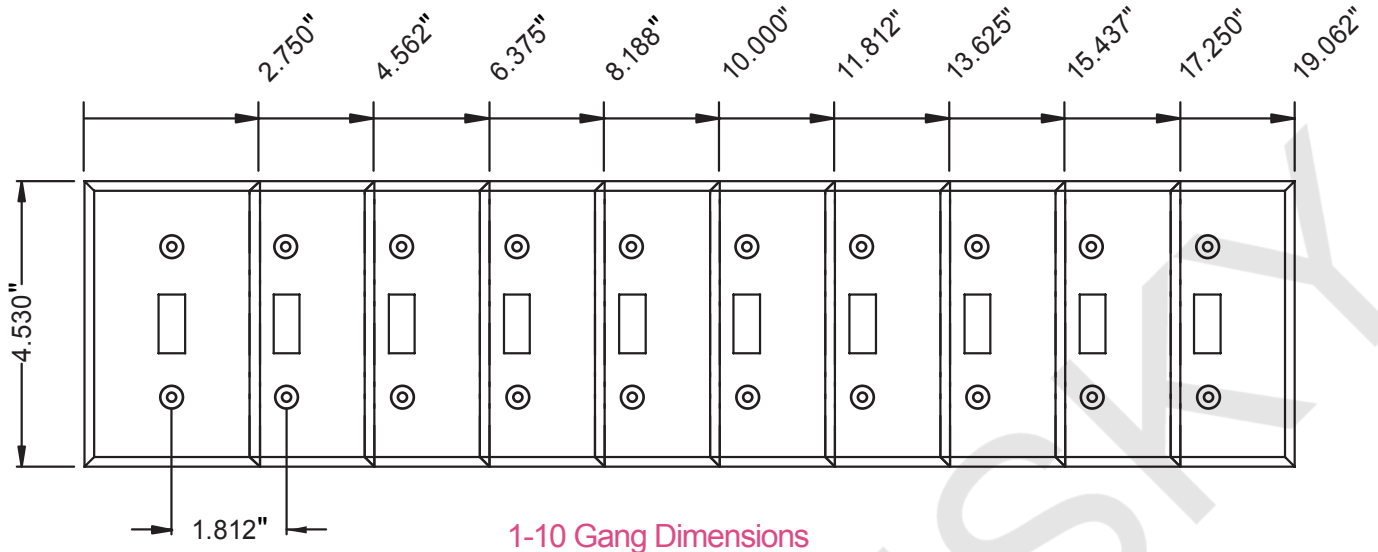

WB-01SS

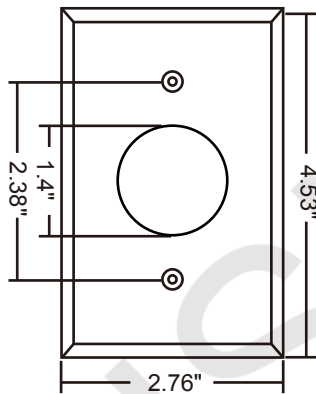

WSR-01SS

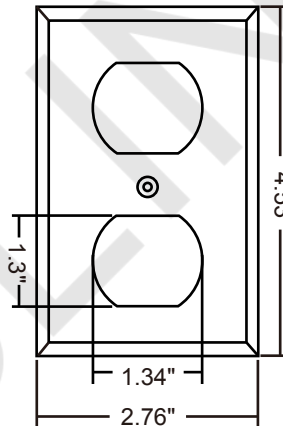

WDR-01SS

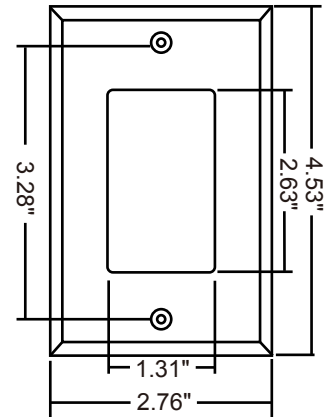

WDG-01SS

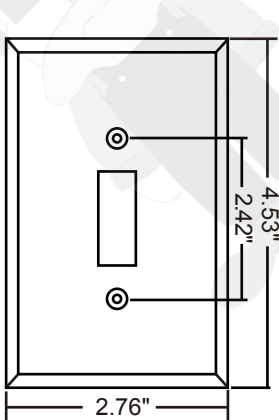

WTS-01SS

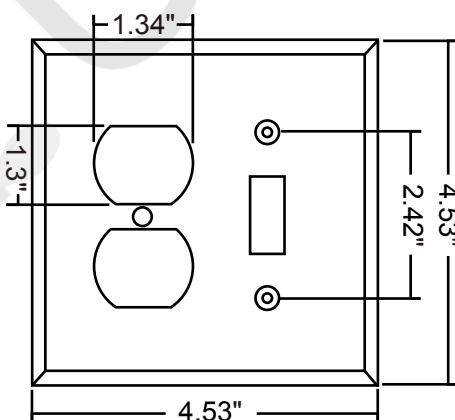

WMX-DGSS

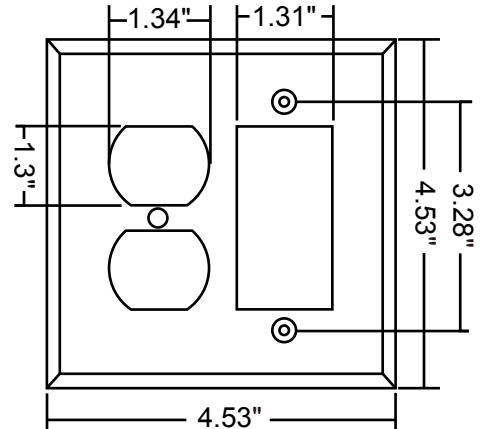

WMX-TDSS





EXR-1

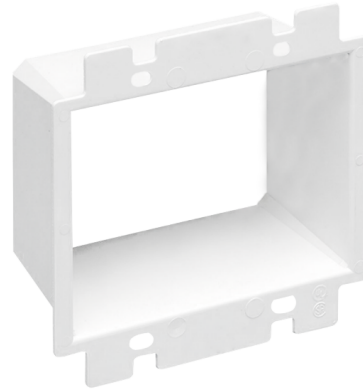

EXR-2

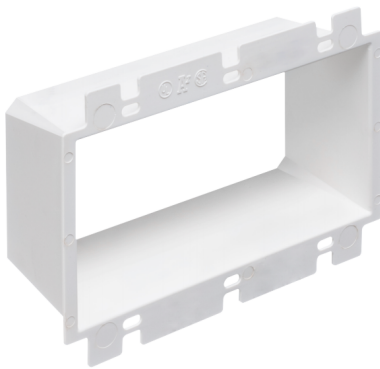

EXR-3

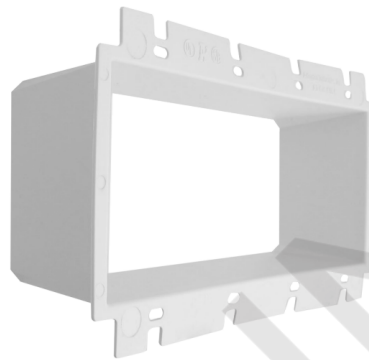

EXR-4



EXR-5

Ordering Information:

Description	Catalog no.	QTY/CTN
Single gang electrical outlet box extender	EXR-1	400pcs
Two gang electrical outlet box extender	EXR-2	200pcs
Three gang electrical outlet box extender	EXR-3	200pcs
Four gang electrical outlet box extender	EXR-4	100pcs
Ceiling box extender/Set back ceilings	EXR-5	200pcs



Dimensional Drawings:

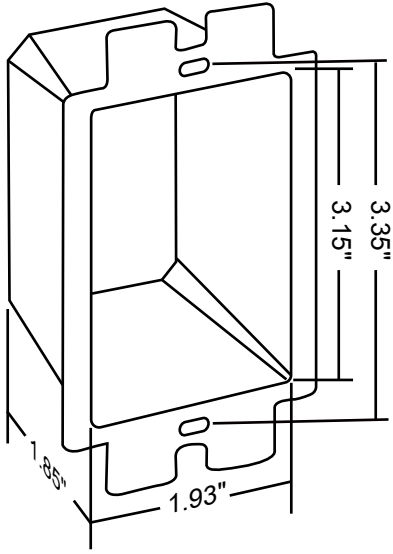

EXR-1

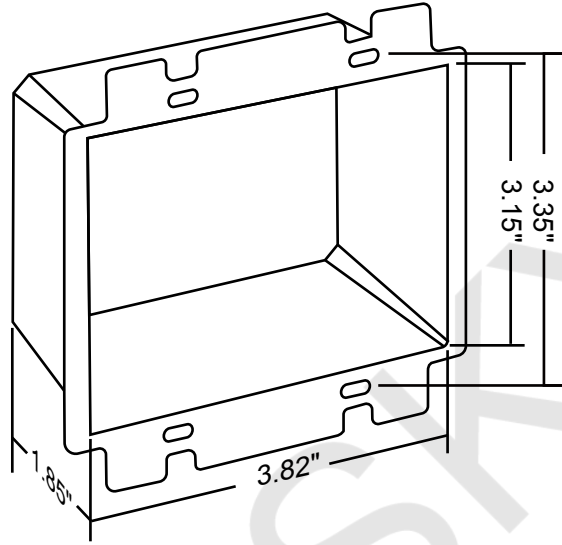

EXR-2

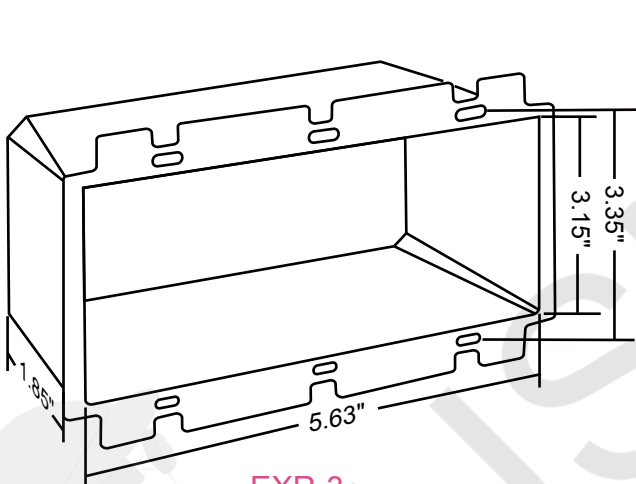

EXR-3

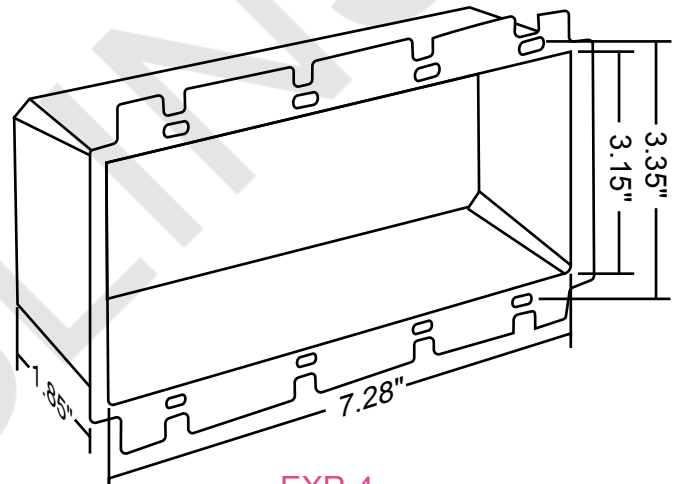

EXR-4

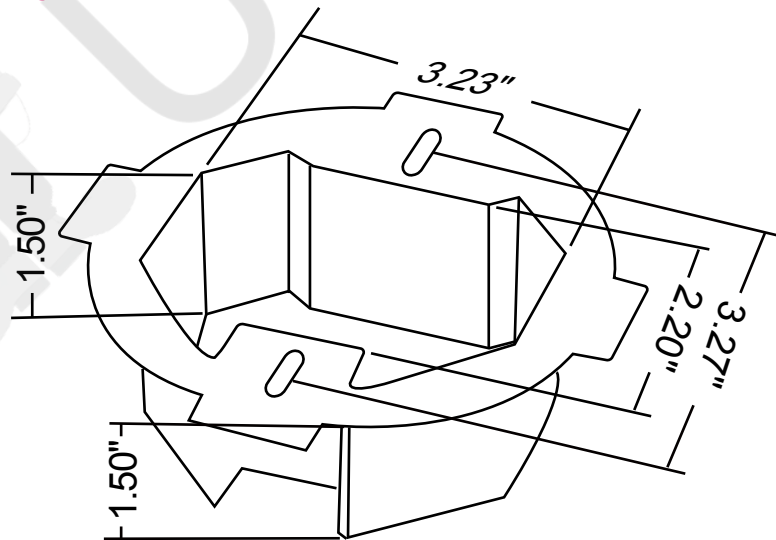

EXR-5



This authorizes the application of the Certification Mark(s) shown below to the models described in the Product(s) Covered section when made in accordance with the conditions set forth in the Certification Agreement and Listing Report. This authorization also applies to multiple listee model(s) identified on the correlation page of the Listing Report.

This document is the property of Intertek Testing Services and is not transferable. The certification mark(s) may be applied only at the location of the Party Authorized To Apply Mark.

Applicant: Shanghai Linsky Electrical Co., Ltd.

Manufacturer: Shanghai Linsky Electrical Co., Ltd.

Address: No. 14 Lane 1515 Yuandong Road, Fengxian District Shanghai City

Address: No. 14 Lane 1515 Yuandong Road, Fengxian District Shanghai City

Country: China
Contact: Mr. Huanhe Zheng
Phone: 86-18017201925
FAX: -
Email: sales@linsky.cn

Country: China
Contact: Mr. Huanhe Zheng
Phone: 86-18017201925
FAX: -
Email: sales@linsky.cn

Party Authorized To Apply Mark: Same as Manufacturer
Report Issuing Office: Intertek Testing Services Shanghai Limited

Control Number: 5010519

Authorized by: _____
for L. Matthew Snyder, Certification Manager



This document supersedes all previous Authorizations to Mark for the noted Report Number.

This Authorization to Mark is for the exclusive use of Intertek's Client and is provided pursuant to the Certification agreement between Intertek and its Client. Intertek's responsibility and liability are limited to the terms and conditions of the agreement. Intertek assumes no liability to any party, other than to the Client in accordance with the agreement, for any loss, expense or damage occasioned by the use of this Authorization to Mark. Only the Client is authorized to permit copying or distribution of this Authorization to Mark and then only in its entirety. Use of Intertek's Certification mark is restricted to the conditions laid out in the agreement and in this Authorization to Mark. Any further use of the Intertek name for the sale or advertisement of the tested material, product or service must first be approved in writing by Intertek. Initial Factory Assessments and Follow up Services are for the purpose of assuring appropriate usage of the Certification mark in accordance with the agreement, they are not for the purposes of production quality control and do not relieve the Client of their obligations in this respect.

Intertek Testing Services NA Inc.
545 East Algonquin Road, Arlington Heights, IL 60005
Telephone 800-345-3851 or 847-439-5667 Fax 312-283-1672

Standard(s):	Cover Plates For Flush-Mounted Wiring Devices [UL 514D:2013 Ed.2+R:04Mar2016] Cover Plates For Flush-Mounted Wiring Devices [CSA C22.2#42.1:2013 Ed.2+G1]
Product:	Cover plate
Brand Name:	USLINSKY

Models:

WB-01, WB-02, WB-03, WB-04, WB-05, WB-06, WSR-01, WSR-02, WSR-03, WSR-04, WSR-05, WSR-06, WDR-01, WDR-02, WDR-03, WDR-04, WDR-05, WDR-06, WDG-01, WDG-02, WDG-03, WDG-04, WDG-05, WDG-06, WDG-01M, WDG-02M, WDG-03M, WDG-04M, WDG-05M, WDG-06M, WDG-01L, WDG-02L, WDG-03L, WDG-04L, WDG-05L, WDG-06L, CZX-01, CZX-02, WTS-01, WTS-02, WTS-03, WTS-04, WTS-05, WTS-06, WMX-TD, WMX-TG, WMX-DG, WMX-BT, WMX-BD, WMX-BG, WMX-DS, WMX-GS, WSL-01, WSL-02, WSL-03, WSL-04, WSL-05, WSL-06, WMB-01, WMG-01, WMT-01, WMD-01, WMS-01, WT-11, LTSC-01, LTSC-02, Staco90-069, WB-01SS, WB-02SS, WB-03SS, WB-04SS, WB-05SS, WB-06SS, WSR-01SS, WSR-02SS, WSR-03SS, WSR-04SS, WSR-05SS, WSR-06SS, WDR-01SS, WDR-02SS, WDR-03SS, WDR-04SS, WDR-05SS, WDR-06SS, WDG-01SS, WDG-02SS, WDG-03SS, WDG-04SS, WDG-05SS, WDG-06SS, WTS-01SS, WTS-02SS, WTS-03SS, WTS-04SS, WTS-05SS, WTS-06SS, WMX-TDSS, WMX-TGSS, WMX-DGSS, WMX-BTSS, WMX-BDSS, WMX-BGSS, WMX-DSSS, WMX-GSSS

This authorizes the application of the Certification Mark(s) shown below to the models described in the Product(s) Covered section when made in accordance with the conditions set forth in the Certification Agreement and Listing Report. This authorization also applies to multiple listee model(s) identified on the correlation page of the Listing Report.

This document is the property of Intertek Testing Services and is not transferable. The certification mark(s) may be applied only at the location of the Party Authorized To Apply Mark.

Applicant: Shanghai Linsky Electrical Co., Ltd.
Address: No. 14 Lane 1515 Yuandong Road, Fengxian District Shanghai City
Country: China
Contact: Mr. Huanhe Zheng
Phone: 18017201925
FAX: -
Email: sales@linsky.cn

Manufacturer: Shanghai Linsky Electrical Co., Ltd.
Address: No. 14 Lane 1515 Yuandong Road, Fengxian District Shanghai City
Country: China
Contact: Mr. Huanhe Zheng
Phone: 18017201925
FAX: -
Email: sales@linsky.cn

Party Authorized To Apply Mark: Same as Manufacturer
Report Issuing Office: Intertek Testing Services Shanghai

Control Number: 5010519

Authorized by: _____

for L. Matthew Snyder, Certification Manager



This document supersedes all previous Authorizations to Mark for the noted Report Number.

This Authorization to Mark is for the exclusive use of Intertek's Client and is provided pursuant to the Certification agreement between Intertek and its Client. Intertek's responsibility and liability are limited to the terms and conditions of the agreement. Intertek assumes no liability to any party, other than to the Client in accordance with the agreement, for any loss, expense or damage occasioned by the use of this Authorization to Mark. Only the Client is authorized to permit copying or distribution of this Authorization to Mark and then only in its entirety. Use of Intertek's Certification mark is restricted to the conditions laid out in the agreement and in this Authorization to Mark. Any further use of the Intertek name for the sale or advertisement of the tested material, product or service must first be approved in writing by Intertek. Initial Factory Assessments and Follow up Services are for the purpose of assuring appropriate usage of the Certification mark in accordance with the agreement, they are not for the purposes of production quality control and do not relieve the Client of their obligations in this respect.

Intertek Testing Services NA Inc.
545 East Algonquin Road, Arlington Heights, IL 60005
Telephone 800-345-3851 or 847-439-5667 Fax 312-283-1672

Standard(s):	Non-Metallic Outlet Boxes, Flush-Device Boxes, And Covers [UL 514C:2014 Ed.4+R:10 Dec2014] Nonmetallic Outlet Boxes (R2016) [CSA C22.2#18.2:2006 Ed.1+U1]
Product:	Extension ring
Brand Name:	USLINSKY, ELECTRIMART
Models:	EXR-1, EXR-2, EXR-3, EXR-4, EXR-5

SHANGHAI LINSKY ELECTRICAL CO.,LTD

 +86-21-67107908

 sales@linsky.cn

 www.shlinsky.com

 Office Add : Room 1002, #2 Building, Phoenix Creativity
Valley, Lane 1588 Huhang Highway, Fengxian, SH
Factory Add: #29, Lane 1888 Daye Highway, Fengxian, SH